

KOBELCO

DRIVEN BY
PASSION

Building Demolition Machine

SK350D LC

SK350DLC-10



Complies with the latest exhaust emission regulations



US EPA
Tier IV Final



EU (NRMM)
Stage IV



Japanese
Regulations

Designed and built to save time and get you up and working!!

The KOBELCO demolition machine utilizes a common use type base boom and exclusive NEXT attachment joint for the Ultra long front, boom insert and the Separate boom.

KOBELCO' s demolition machines with the exclusive NEXT joint systems are made so you can set up or change work fronts quick and easy to get the job done. With the ability to change tools on site and work at multiple heights with a single machine, the productivity is maximized with the needs of the job.

The machine can be quickly set up and adapted to meet the job requirement and be use for the full duration of the job instead of swapping out machines.

Due to the unique structure of this attachment, transport can be completed safely and with just a few steps. Add that to the excellent fuel savings and machine durability, KOBELCO helps provide the owner reduced operational costs, less downtime and greater return on investment.

KOBELCO' s SK350DLC demolition machine is the next generation of high performance and cutting edge technology. It' s ready to go to work for you.

Focus on operation rate resulting in a machine with common use type base boom

Previous demolition machines had a structure that basically did not allow attachments to be exchanged, meaning one complete machine was required for each specification. Having machines each dedicated to its specialty was useful onsite, but this meant that the operation rate was low and users were required to own multiple machines. KOBELCO's solution was to develop a machine structure that enabled one machine to be adapted to multiple specifications. Our solution took form in the shape of the machine with common use type base boom.

The NEXT system, created with focus on the site



A machine with common use type base boom is transported by separating the main body and its attachments, requiring less time for set-up after arriving onsite. KOBELCO studied in detail how the assembly work could be completed safely in a short time. We threw out the previous fixed concepts about attachments and developed an innovative attachment that incorporated our various ideas, resulting in the NEXT system.





SK350D LC



Ultra long attachment specification
[11'6" (3.5m) boom insert]



Ultra long attachment specification
[Without boom insert]

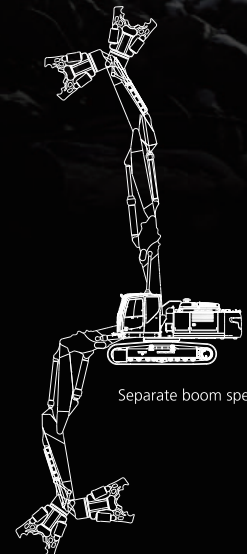

Separate boom specification

Work setups done quickly and safely! The new-generation NEXT demolition attachment



NEXT attachment

The new-generation NEXT demolition attachment for the demolition machine with common use type base boom was designed by KOBELCO without being limited by existing concepts. Each boom attachment has a block structure that simplifies assembly/disassembly and transport, and the attachments employ our original NEXT joint system. The piping can be connected at ground level, and the steps for attachment assembly/disassembly from pressure release to pin fixing can be completed safely in a short time.

■ NEXT joint system

KOBELCO's original joint system was developed by testing the assembly/disassembly process extensively. The boom attachment can be connected just by hooking the upper (backside) pin and fixing with the separate opposing pins on the lower side (bottom side).

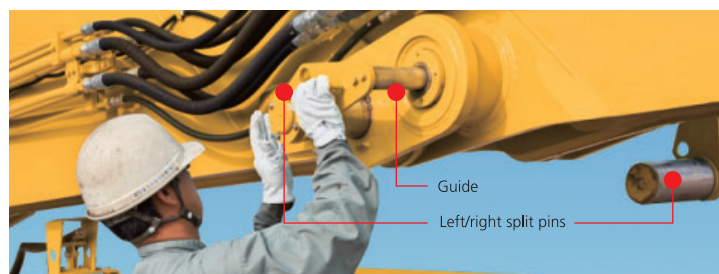
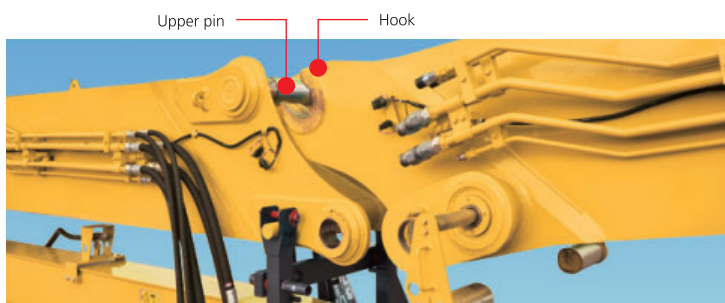
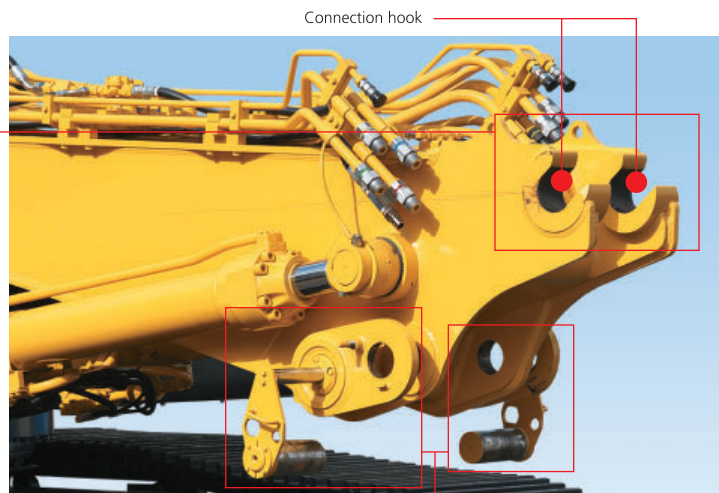
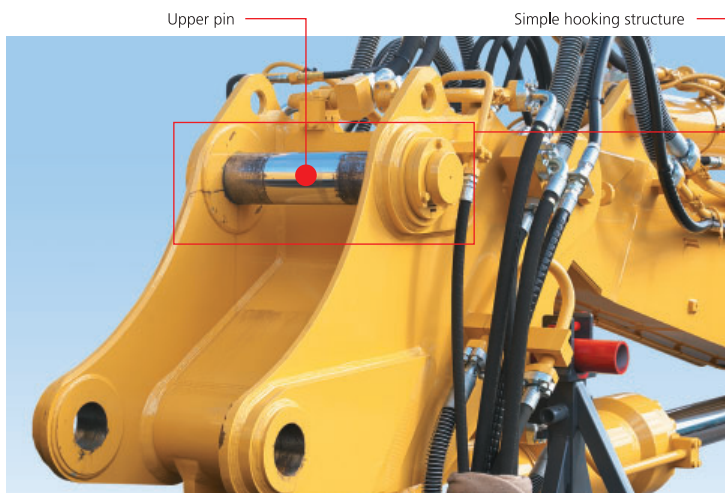

Upper side (back side): Pins just need to be hooked. There is no need to insert/remove the pins.

Lower side (bottom side): Guided left/right separate opposing pins make it easy to position the pins.



Separate boom specification

■ Side-mounted hydraulic piping

All attachment joints have the hydraulic piping mounted on the side, adopting hydraulic quick coupler system for connecting sections.



Piping connection: Hydraulic quick coupler system on the side of the boom.

■ Attachment height during transport [NEXT ultra long attachment specification]

The 3-piece NEXT ultra long attachment is designed with the jib cylinder and arm cylinder crossed over the short inter arm, and the back of the arm is flat. The height while in the stored state has been lessened to approx. 6'7" (2m) to lower the entire height during transport.

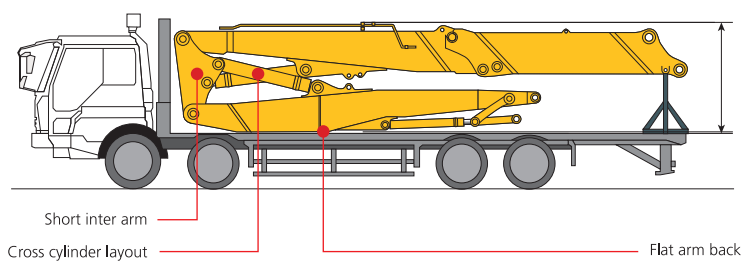

Approx.
6'8"
(2,030mm)

Boom attachments can be changed easily, enabling a high machine operation rate



Ultra long attachment specification

The ultra long attachment enables demolition work at high places to be performed from the ground. The maximum work height is at the top level for this class, and this machine can be used for the demolition of common buildings up to seven stories high. The length can be shortened by removing the boom insert.

Maximum work height

Approx. **68'11" (21.0m)**

With 11'6" (3.5m) boom insert

Approx. **57'5" (17.5m)**

Without boom insert

Note: The measurement is for the arm bucket pin position.

Separate boom specification

The separate boom specification has a wide working range, making work at lower elevations and below ground level easy. The impressive maximum work depth exceeds 19'6", and a large diameter jib cylinder is attached to the boom bottom side to ensure substantial lifting power. This specification is suitable for demolition of the lower floors, underground floors, and foundations of buildings.

Maximum work depth

20'9" (6,320mm)

Note: The measurement is for the arm bucket pin position.

Large front attachment

A 3-ton class large tool can be attached to the ultra long attachment specification. Powerful crushing can be performed at high floor levels for more efficient work progress. The separate boom specification can handle up to 4-ton class tools.

Tool limit weight

Ultra long attachment specification

5,700lbs (2,600kg)

Separate boom specification

8,800lbs (4,000kg)

New cluster gauge

A new color multi-display with multi-function indicators is installed. In addition to gauges and information such as fuel consumption, maintenance, working radius/boom angle, and rear view camera images, the selected attachment mode and mounted front attachment are also displayed.



Fuel consumption

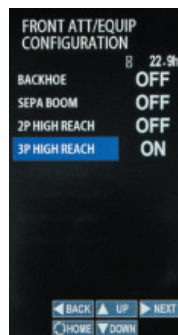

Attachment mode selection screen

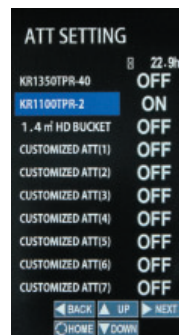

Front attachment selection screen



Ultra long attachment specification
20'(6.1m) arm + 11'6" (3.5m) boom insert

Fuel costs can be reduced with outstanding low fuel consumption and mode selection



New environmental engine

A new electronically controlled engine with high power and low fuel consumption is installed. Particulate matter and NOx emissions are suppressed through the engine's high combustion efficiency, exhaust gas after-treatment equipment, and urea SCR system. The engine also conforms to EPA Tier IV Final regulations.



AIS (Auto Idle Stop)

This idling stop function eliminates wasteful fuel consumption while waiting between operations. The engine stops automatically when the operation lever continues to remain in the locked state.

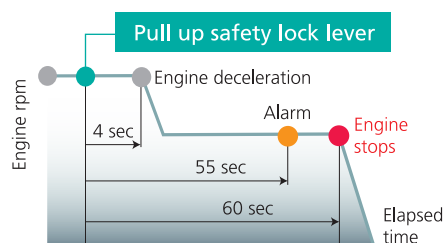

Fuel consumption mode

A function is provided for switching modes to prioritize fuel consumption depending on the work content. Modes can be switched while using any front attachment including the nibbler, breaker, or bucket.



- H mode**
When prioritizing work volume
- S mode**
When prioritizing the balance between work volume and fuel consumption
- E mode**
When extensively prioritizing fuel consumption

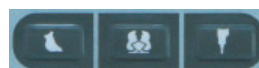

Bucket / nibbler / breaker mode switch

Enhanced safety functions to assist the operator in production and performance

New cab interference prevention system

The cab interference prevention system is standard on the SK350D. This feature sounds an alarm and prevents the machine from allowing the working tool to come into contact with the cab during operation. Current tool position can be detected with high accuracy so the tool can be moved at close range near the cab, resulting in increased safe working range.

System configuration

The system calculates the various boom, attachment and idler link angles to create a proximity to the cab in order to prevent cab interference.



System operation

As the working tool approaches the cab, alarm is sounded before any contact can occur, and the machine automatically prevents tool from making contact with the cab.



Stability warning system

The working radius and stability are calculated from the position of the attachment, and the operator is warned with a alarm (continuous sound) where the machine's stability could be compromised.



Swing angle sensor

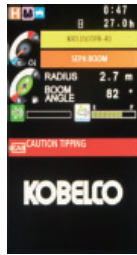
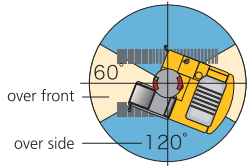

The working range is largest when working in-line with the track frame or over front of machine. For maximum stability and safety, Kobelco recommends working in-line with the track frame whenever possible.

Demolition structure cab

The adjoining edge of the top and front windows are free of view-obstructing pillars, and radial type grid guards are installed on front and upper sides. This gives the operator an unobstructed and continuous view from ground level to the maximum working height.



- ISO 10262 level II FOPS front and top guards.
- The cab guards can be opened and closed without tools, and the glass can be cleaned easily.
- Vertical open/close roller shades that can be stopped at any position.
- Laminated front window.

Multiple standard features and accessories for ensuring safety



Tilting cab This picture is from different model
Tilting cab is standard.



Rear view camera
The rear view camera is displayed on the multi-display.



Right side camera + monitor*
Rear and side camera views can be displayed on the separate monitor.



Boom, arm and jib holding valves
Standard - to prevent boom or arm from falling if hose is damaged.



Cab with two lights
Cab mounted lights are standard.



Travel alarm
The alarm cautions workers in the area that the machine is traveling.



Swing flasher & Rear work light
The swing warning lamp helps prevent collisions and accidents while the upper body is turning.



Falling object deflector
The guard deflects falling debris away from the machine. This is standard for the ultra long attachment.

* The accessory settings may differ according to the class or specification. Refer to the list of key accessories on the back page for details.

Highly durable structure to show enduring excellent performance in hard operations

Factory engineered Heavy Duty boom and arm [Ultra long attachment]

- Lifting eyes are provided.
- Hoses are routed for easy maintenance.



Hydraulic oil filter restriction indicator

Clogging is detected by the pressure difference at the filter entrance and exit, and warnings are displayed on the color multi-display. Hydraulic equipment trouble can be prevented by taking action before contaminants enter the hydraulic oil tank.

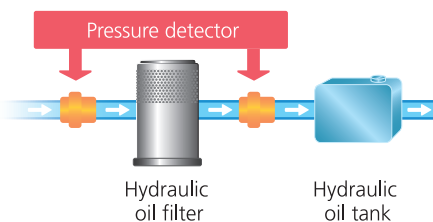

Dedicated arm for the ultra long attachment

Various reinforcements and protective structures are incorporated in the arm section to prevent damage from contact or flying debris.



- Guided reinforced bucket cylinder guard with box-type structure



- Electric wiring with optimized routing and full cover for preventing damage



- Hoses routed to protect from damages



- Guarded work LED lights

Various functions and accessories for the longevity of the machine



Upper frame under cover guards

The 0.24" (6mm) thick reinforced cover protects the inner devices & engine unit.



Swivel guard

The lower car body structure is fitted underneath with a 0.35" (9mm) thick reinforced cover.



Dust suppression system (with drainage circuit)*

A drainage circuit is newly installed to prevent rusting valves. The pipe can be drained after sprinkle water.



New hydraulic oil filter

Glass filtration material with outstanding cleaning ability and durability is used.



Air cleaner (double element)

The double filter structure and large capacity prevent dust from being sucked in.



Auto lubrication system

The attachment is automatically oiled at specified times. Eliminates the trouble of oiling before starting work.



Additional tool box

A large storage box for storing tools is provided.



Maintenance space

The space above the car body allows workers to inspect under the hood in comfortable positions.

* The accessory settings may differ according to the class or specification. Refer to the list of key accessories on the back page for details.

Specifications

Engine

Model	HINO JO8E-VV
Type	Water-cooled, 4cycle 6cylinder direct injection type diesel engine with intercooler turbo-charger (complies with EU (NRMM) Stage IV, EPA Tier IV Final)
No. of cylinders	6
Bore and stroke	4.41" {112 mm} x 5.12" {130 mm}
Displacement	468.9 cu.in {7.684 L}
Rated power output	201 kW/2,100 min ⁻¹ (ISO 9249) 213 kW/2,100 min ⁻¹ (ISO 14396)
Max. torque	729 lb-ft / 1,600 rpm {988 N·m / 1,600min ⁻¹ } (ISO 9249 : with fan) 750 lb-ft / 1,600 rpm {1,017 N·m / 1,600min ⁻¹ } (ISO 14396 : Without fan)

Hydraulic System

Pump	
Type	Parallel variable displacement piston pumps
Max. discharge flow	Main pumps 2 x 77.7 U.S.gpm {294 L/min} Pump for pilot circuit 1 x 5.3 U.S. gpm {20 L/min}
Relief valve setting	
Excavating circuits (main)	4,550 psi {31.4 MPa}
Travel circuit	4,970 psi {34.3 MPa}
Swing circuit	4,210 psi {29.0 MPa}
Pilot control circuit	725 psi {5.0 MPa}
Nibbler(Crusher) circuit	Open&Close 3,553 psi {24.5 MPa} Rotation(Option) 2,988 psi {20.6 MPa}
Main control valve	8-spool

Swing System

Swing motor	One fixed displacement piston pump
Brake	Hydraulic
Parking brake	Wet multiple plate
Swing speed	Separate attachment 10.0 rpm {10.0 min ⁻¹ } 3-piece ultra long attachment 5.5 rpm {5.5 min ⁻¹ }
Swing torque	119.6 kN·m
Tail swing radius	3,600 mm
Min. front swing radius	4,310 mm

Operating Weight & Ground Pressure

Attachment Type	3-piece ultra long attachment/equipment		Separate attachment
	11'6" {3.5 m} boom insert	Without boom insert	
Operating Weight	99,700 lbs {45,200 kg}	96,000 lbs {43,600 kg}	100,400 lbs {45,500 kg}
Ground Pressure	12 psi {84 kPa}	12 psi {81 kPa}	12 psi {85 kPa}

Travel System

Travel motors	Variable displacement piston pump
Travel brakes	Hydraulic
Parking brakes	Wet multiple plate
Travel shoes	48 each side
Travel speed (high/low)	5.6/3.3 km/h
Drawbar pulling force	72,200 lbs {321 kN}{SAE J 1309}
Gradeability	70 % {35 deg}

Cab & Control

Cab	All-weather, sound-suppressed steel cab mounted on the silicon-sealed suspension mounts lled with silicone oil and equipped with a heavy, insulated floor mat.
Control	Two hand levers and two foot pedals for travel Two hand levers for excavating and swing Electric rotary-type engine throttle

Boom, Arm & Bucket

3-piece ultra long attachment	
Boom cylinders	2-6.7" {170 mm} x 4'11" {1,505 mm}
Arm cylinder	1-6.7" {170 mm} x 4' {1,210 mm}
Bucket cylinder	1-4.9" {125 mm} x 3'11" {1,200 mm}
Jib cylinders	2-5.5" {140 mm} x 4' {1,210 mm}
Separate attachment	
Boom cylinders	2-6.7" {170 mm} x 4'11" {1,505 mm}
Arm cylinder	1-6.7" {170 mm} x 5'10" {1,788 mm}
Bucket cylinder	1-5.9" {150 mm} x 3'11" {1,193 mm}
Jib cylinders	1-9.4" {240 mm} x 4'4" {1,317 mm}

Refilling Capacities & Lubrications

Fuel tank	132.9 U.S.gal {503 L}
Cooling system	9.2 U.S.gal {35 L}
Engine oil	7.5 U.S.gal {28.5 L}
Travel reduction gear	2x2.1 U.S.gal {2x8.0 L}
Swing reduction gear	2.0 U.S.gal {7.4 L}
Hydraulic oil tank	64.7 U.S.gal {245 L} tank oil level 108.3 U.S.gal {410 L} hydraulic system
DEF/AdBlue tank	21.9 U.S.gal {83 L}

Dimensions (main body + base boom)

(Unit: ft-in {mm})

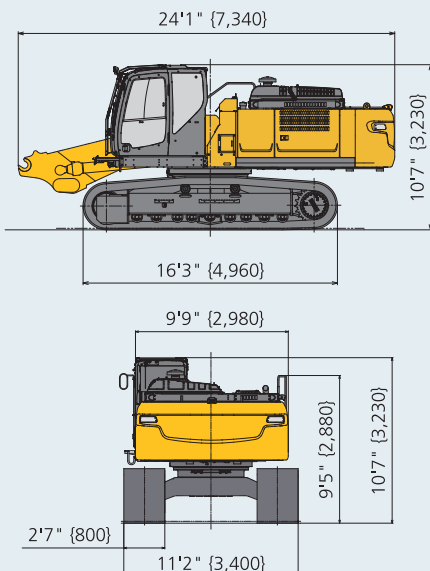

Assembled machine dimensions (Unit: ft-in {mm})

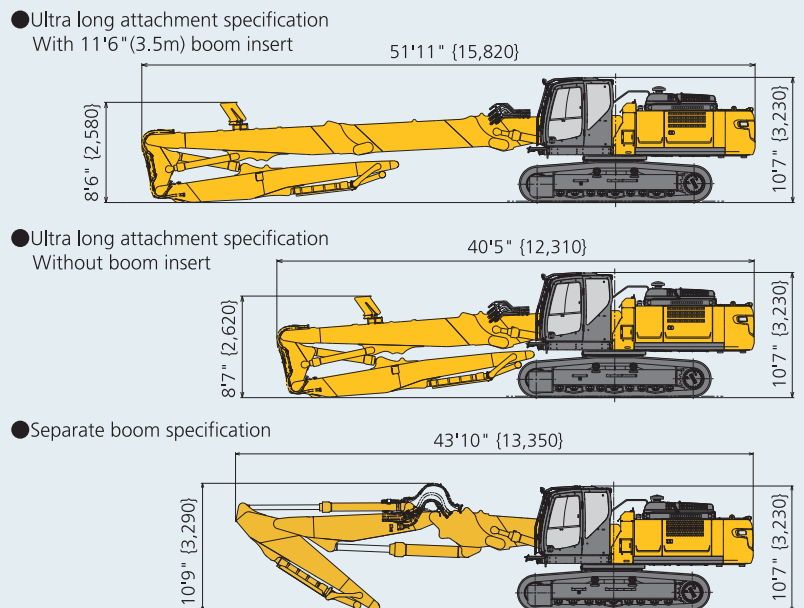

Disassembled dimensions and weight (Unit: ft-in {mm}, lbs {kg})

Main body + base boom

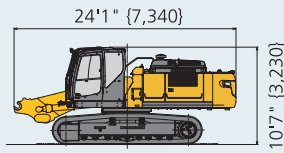

Weight: 77,800 lbs {35,300 kg}

Main body + base boom (without counterweight)

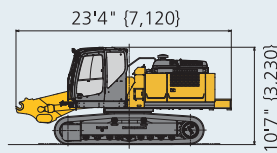

Weight: 56,900 lbs {25,800 kg}

Main body + base boom + boom insert

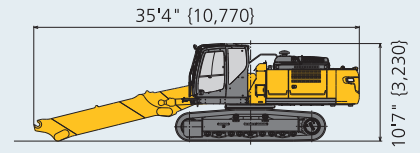

Weight: 81,400 lbs {36,900 kg}

Main body + base boom + boom insert (without counterweight)

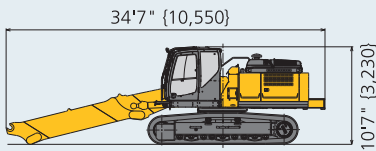

Weight: 60,600 lbs {27,500 kg}

Counterweight

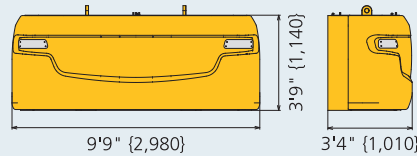

Weight: 20,900 lbs {9,460 kg}

Ultra long attachment
20'(6.1m) arm + 11'6"(3.5m) boom insert (including enclosed stand)

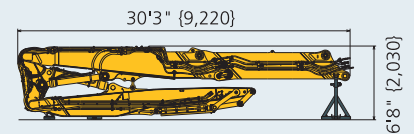

Overall width: 5'10"-ft-in {1,770 mm} Weight: 16,300 lbs {7,390 kg}

Ultra long attachment
20'(6.1m) arm (including enclosed stand)

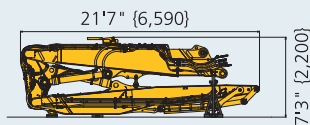

Overall width: 5'10"-ft-in {1,770 mm} Weight: 12,600 lbs {5,730 kg}

Ultra long attachment
11'6"(3.5m) boom insert (including optional stand)

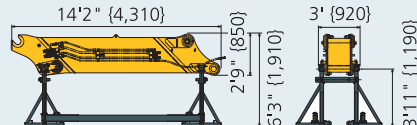

Overall width: 5'10"-ft-in {1,770 mm} Weight: 4,210 lbs {1,910 kg}

Separate boom (including enclosed stand)

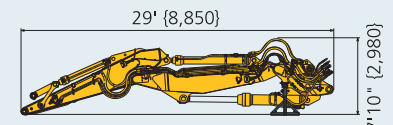

Overall width: 5'10"-ft-in {1,770 mm} Weight: 14,200 lbs {6,440 kg}

Working range (Unit: ft-in {mm}) The measurements do not include crawler shoe lugs. Working ranges with max tool weight installed.

- Ultra long attachment specification
With 11'6"(3.5m) boom insert

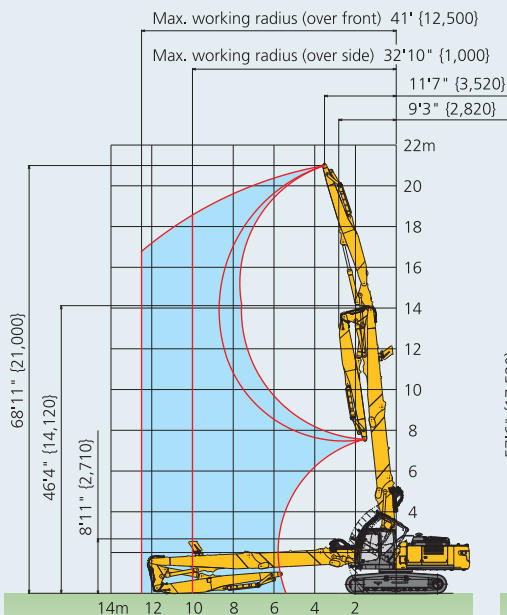

- Ultra long attachment specification
Without boom insert

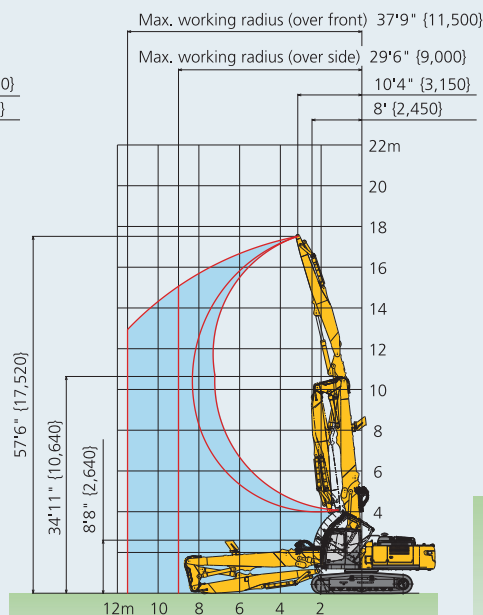

- Separate boom specification

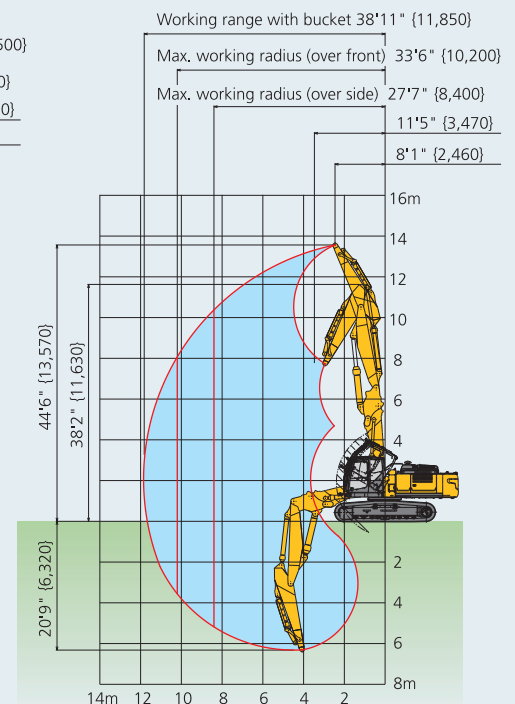

STANDARD EQUIPMENT

Note: Standard and optional equipment may vary. Consult your KOBELCO dealer for specifics.

- ENGINE**
- Turbocharged and inter-cooled
- HINO J08EVV-KSPD Tier IV Final Diesel engine
- Automatic engine deceleration
- Two 12 V, 112 Ah batteries
- 24 V, 5 kW starting motor
- 60-amp alternator
- Removable radiator clean-out screen
- Automatic engine shut-down if low engine oil pressure
- Side by side oil, hydraulic and engine radiators
- Double-element air cleaner
- CONTROL**
- Working mode selector (H-mode, S-mode and ECO-mode)
- HYDRAULIC**
- Exclusive boom to arm regeneration systems
- Auto warm-up system
- Hydraulic oil cooler
- Hydraulic oil filter condition indicator
- SWING SYSTEM & TRAVEL SYSTEM**
- Swing rebound prevention system
- Independent travel system
- Swing rebound prevention system
- Independent travel system
- Swing rebound prevention system
- Independent travel system
- Two-speed travel with automatic down shift
- Sealed & lubricated track links
- 31.5" (800 mm) shoes
- Grease-type track adjusters
- Automatic swing brake
- Lower track guards
- MIRRORS, LIGHTS & CAMERAS**
- Three rearview mirrors
- Rear-view camera
- Three front working lights (1 on upper carriage, 2 on cab)
- Attachment front work light (separate boom: 2, ultra long attachment: 2)
- Swing frashers
- Right side camera, additional monitor
- Cab foot light
- Cab foot mirror
- CAB & CONTROL**
- Tilt cab
- Demolition structure cab
- Two pilot-operated control levers
- Electric horn
- Integrated left-right slide-type control box
- All-weather, sound-insulated cab
- Tinted safety glass
- Easy to read multi-display monitor
- Automatic climate control
- Defroster
- Mechanical suspension seat
- Headrest
- Interior cab light
- Coat hook
- Bluetooth installed radio (AM/FM Stereo with speakers)
- Luggage tray
- Large cup holder
- Detachable two-piece floor mat
- Handrails
- Wiper (top and front window)
- Emergency escape hammer
- Travel alarm
- Attachment pressure release switch
- Manual DPF regeneration switch
- 12 V converter
- Two-way control pattern changer
- Tip-over warning device
- Cab interference prevention system
- Boom & arm & jib cylinder holding valves
- Slow return check valve
- 0.35" (9mm) thick swivel guard
- 0.24" (6mm) thick upper frame under cover guards
- Auto lubrication system
- Rotation and N&B auxiliary circuits and piping
- Ultra long or Separate Attachment stand
- Falling object deflector
- Public address system
- KOMEXS
- Pin removal / installation jig
- Dust suppression system
- Additional tool box
- Cab tilt operation alarm
- Cab emergency lowering device
- Crosspiece for operator safety in cab
- Console tilt
- Cab tilt maintenance stopper

OPTIONAL EQUIPMENT

- 23.6" (600mm) shoes
- 27.6" (700mm) shoes
- Boom insert stand
- Full track guards
- Hydraulic oil for cold climates

Lifting Capacities with Separate boom

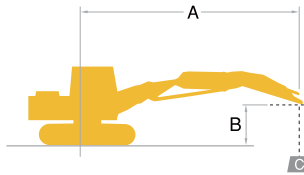

- A – Reach from swing centerline to arm tip
- B – Arm bucket pin height above/below ground
- C – Lifting capacities in pounds (kilograms)

SK350DLC		Separate boom 10'10" (3.3m), without attachment, 2'7" (800mm) track shoes																	
B	A	5' (1.5m)		10' (3.0m)		15' (4.6m)		20' (6.1m)		25' (7.6m)		30' (9.1m)		35' (10.7m)		At Max. Reach		Radius	
		Rating over front	Rating over side or 90 degrees	Rating over front	Rating over side or 90 degrees	Rating over front	Rating over side or 90 degrees	Rating over front	Rating over side or 90 degrees	Rating over front	Rating over side or 90 degrees	Rating over front	Rating over side or 90 degrees	Rating over front	Rating over side or 90 degrees	Rating over front	Rating over side or 90 degrees		
40' (12.2m)	lb (kg)					*23,600 (*10,700)	*23,600 (*10,700)										*17,460 (*7,920)	*17,460 (*7,920)	20'0" (6.10m)
35' (10.7m)	lb (kg)					*21,090 (*9,570)	*21,090 (*9,570)	*20,060 (*9,100)	*20,060 (*9,100)	*13,050 (*5,920)	*13,050 (*5,920)						*13,990 (*6,350)	*13,860 (6,290)	26'7" (8.13m)
30' (9.1m)	lb (kg)					*19,020 (*8,630)	*19,020 (*8,630)	*21,090 (*9,570)	*21,090 (*9,570)	*11,500 (*5,220)	*11,500 (*5,220)	*11,990 (*5,440)	11,330 (5,140)				*12,380 (*5,620)	*10,250 (4,650)	31'2" (9.50m)
25' (7.6m)	lb (kg)			*17,950 (*8,140)	*17,950 (*8,140)	*20,850 (*9,460)	*20,850 (*9,460)	*22,770 (*10,330)	*22,770 (*10,330)	*13,070 (*5,930)	*13,070 (*5,930)	*10,920 (*4,950)	*10,920 (*4,950)				*11,510 (*5,220)	8,320 (3,770)	34'4" (10.47m)
20' (6.1m)	lb (kg)					*35,100 (*15,920)	33,800 (15,330)	*25,290 (*11,470)	21,090 (9,570)	*19,360 (*8,780)	14,780 (6,700)	*11,010 (*4,990)	10,810 (4,900)	*11,030 (*5,000)	8,000 (3,630)		*11,040 (*5,010)	7,190 (3,260)	36'6" (11.15m)
15' (4.6m)	lb (kg)			*32,730 (*14,850)	*32,730 (*14,850)	*34,170 (*15,500)	30,700 (13,960)	*25,010 (*11,340)	18,620 (8,450)	16,790 (7,620)	19,230 (8,720)	13,520 (6,130)	*11,560 (*5,240)	10,140 (4,600)	*11,120 (*5,040)	7,730 (3,510)	10,310 (4,680)	6,510 (2,950)	38'0" (11.59m)
10' (3.0m)	lb (kg)					*24,690 (*11,200)	*24,690 (*11,200)	26,670 (12,100)	16,790 (7,620)	15,560 (7,060)	18,310 (8,310)	11,480 (5,210)	14,170 (6,430)	8,930 (4,050)	11,330 (5,140)	7,100 (3,220)	9,750 (4,470)	6,150 (2,790)	38'8" (11.81m)
5' (1.5m)	lb (kg)					*19,090 (*8,660)	*19,090 (*8,660)	25,300 (11,480)	15,560 (7,060)	18,310 (8,310)	11,480 (5,210)	14,170 (6,430)	8,930 (4,050)	11,330 (5,140)	7,100 (3,220)	9,750 (4,470)	6,150 (2,790)	6,060 (2,750)	38'9" (11.84m)
Ground Level	lb (kg)			*20,220 (*9,170)	*20,220 (*9,170)	*18,280 (*8,290)	*18,280 (*8,290)	*24,210 (*10,980)	15,070 (6,840)	17,850 (8,100)	11,060 (5,020)	13,840 (6,280)	8,620 (3,910)	11,180 (5,070)	6,950 (3,150)	9,980 (4,530)	6,230 (2,830)	38'3" (11.67m)	
-5' (-1.5m)	lb (kg)			*20,540 (*9,320)	*20,540 (*9,320)	*18,300 (*8,300)	*18,300 (*8,300)	24,990 (11,340)	15,280 (6,930)	17,820 (8,080)	11,020 (5,000)	13,790 (6,260)	8,570 (3,890)	11,250 (5,100)	7,020 (3,180)	10,610 (4,810)	6,680 (3,030)	37'0" (11.28m)	
-10' (-3.0m)	lb (kg)	*38,700 (*17,550)	*38,700 (*17,550)	*33,180 (*15,050)	*33,180 (*15,050)	*28,410 (*12,890)	25,120 (11,390)	*19,900 (*9,030)	15,740 (7,140)	*17,830 (*8,090)	11,310 (5,130)	*14,040 (*6,370)	8,810 (4,000)			*8,980 (*4,070)	7,610 (3,450)	34'9" (10.59m)	
-15' (-4.6m)	lb (kg)			*46,940 (*21,290)	*46,940 (*21,290)	*28,980 (*13,150)	26,090 (11,830)	*20,570 (*9,330)	16,480 (7,480)	*15,830 (*7,180)	11,890 (5,390)	*13,180 (*5,980)	9,540 (4,330)			*10,900 (*4,940)	9,570 (4,340)	30'5" (9.26m)	
-20' (-6.1m)	lb (kg)					*30,720 (*13,930)	28,180 (12,780)	*22,150 (*10,050)	18,520 (8,270)							*18,080 (*8,200)	17,990 (8,160)	21'0" (6.39m)	

- Notes:
- Do not attempt to lift or hold any load that is greater than these lift capacities at their specified lift point radius and height. Weight of all accessories must be deducted from the above lift capacities.
 - Lift capacities are based on machine standing on level, firm, and uniform ground. User must make allowance for job conditions such as soft or uneven ground out of level conditions, side loads, sudden stopping of loads, hazardous conditions, experience of personnel, etc.
 - Arm top pin is defined as lift point.
 - The above lift capacities are in compliance with SAE J10567. They do not exceed 87 % of hydraulic lift capacity or 75 % of tipping load. Lift capacities marked with an asterisk (*) are limited by hydraulic capacity rather than tipping load.
 - Operator should be fully acquainted with the Operator's and Maintenance Instructions before operating this machine and rules for safe operation of equipment should be adhered to at all times.
 - Lift capacities apply to only machines as originally manufactured and normally equipped by KOBELCO CONSTRUCTION MACHINERY CO., LTD.
 - This table cannot be applied for high reach demolition machines.
 - Use this machine in the following applications. In specification for ultra long attachment type, demolition work. In specification for separate boom type, demolition work & loading work. Never use the machine for any purpose other than the above applications.
 - Please read carefully the manual before using machine.

Note: This document may contain attachments and optional equipment that are not available in your area. It may also contain photographs of machines with specifications that differ from those sold in your area. Please contact your nearest KOBELCO dealer for items you require. Due to our policy of continuous product improvement, all designs and specifications are subject to change without advance notice. Copyright KOBELCO CONSTRUCTION MACHINERY CO., LTD. No part of this document may be reproduced in any manner without prior written permission from KOBELCO.

KOBELCO CONSTRUCTION MACHINERY U.S.A. INC.

22350 Merchants Way, Katy, Texas 77449
<http://www.kobelco-usa.com/>

Inquiries To: